

17

open tunnel

ball: _____

spot:

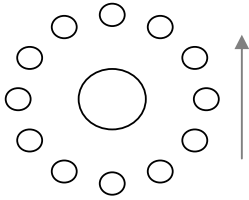

note: _____

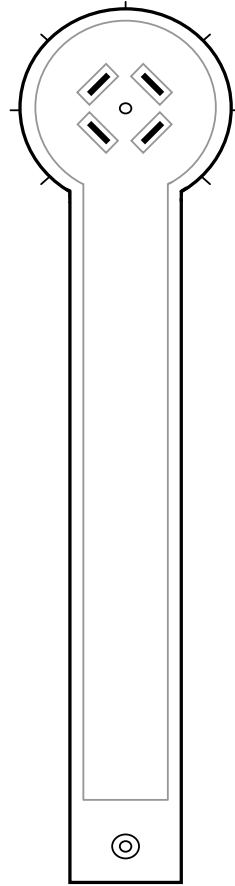
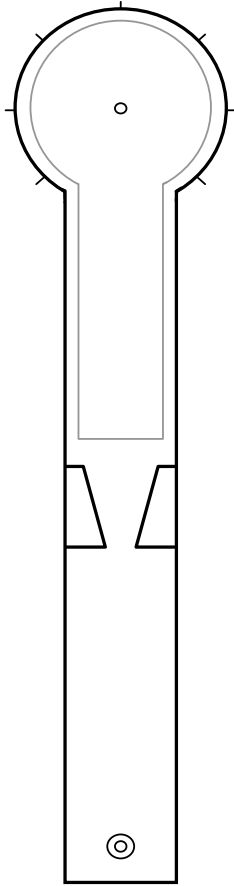

2

Stonehenge

ball: _____

spot:

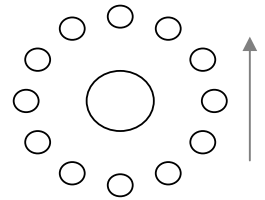

note: _____

15

terrace

ball: _____

spot:

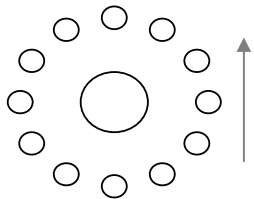

note: _____

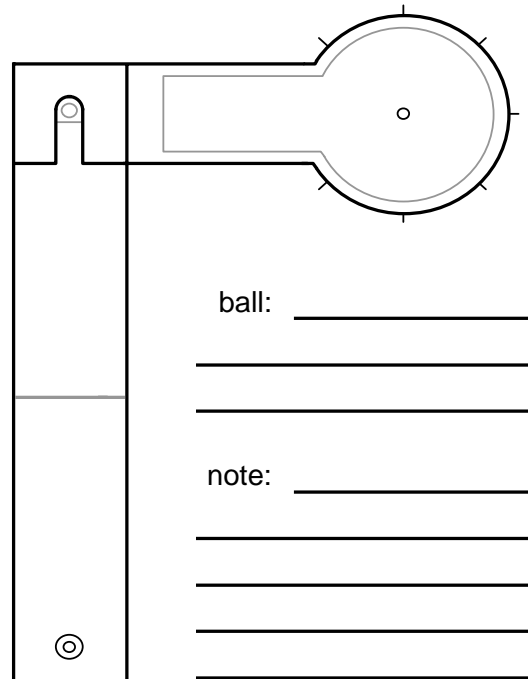
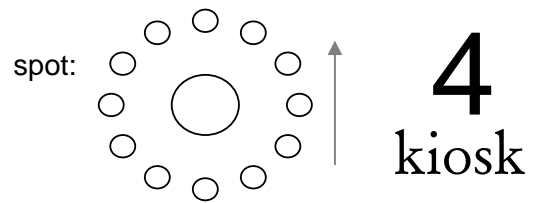
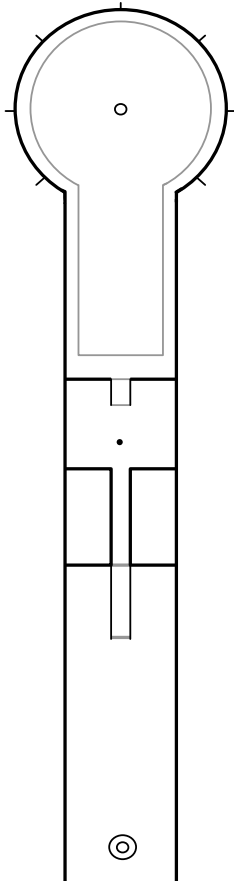

ball: _____

note: _____

3 oyster

ball: _____

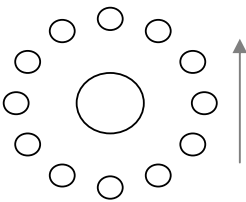
spot: 
note: _____

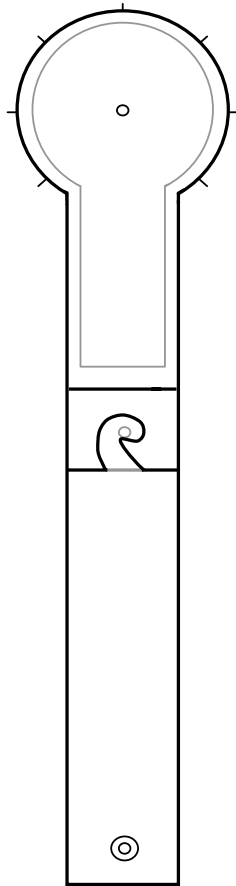

16 tube corner

ball: _____

note: _____

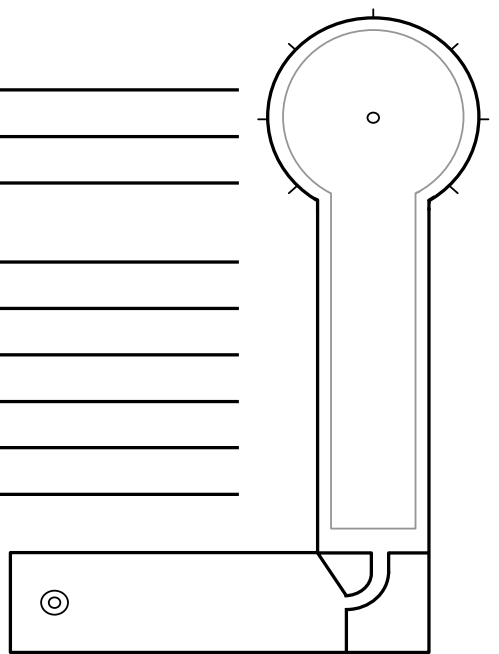

5 velo- drome

ball: _____

note: _____

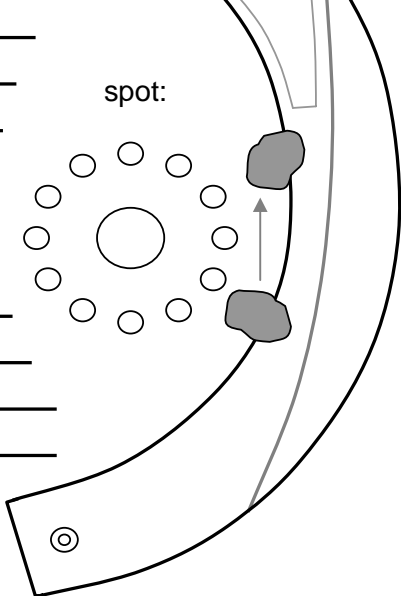

14 stones

ball: _____

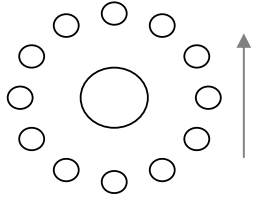
spot: 
note: _____

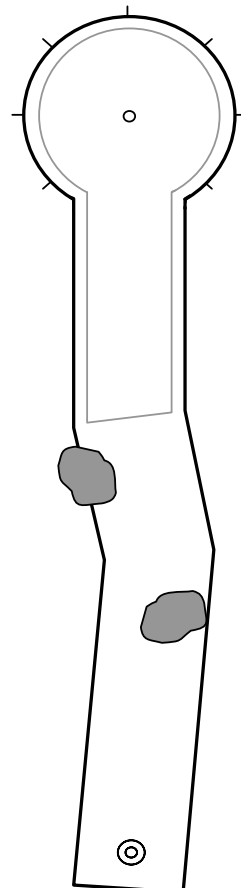

13

double velo

ball: _____

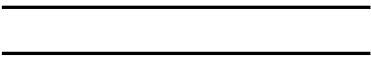

spot: _____

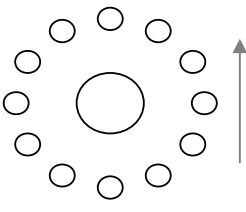

note: _____

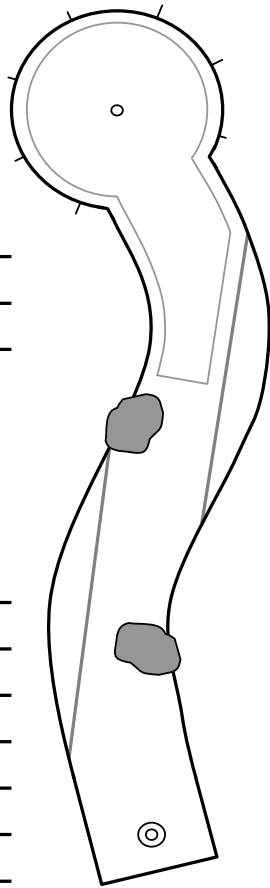
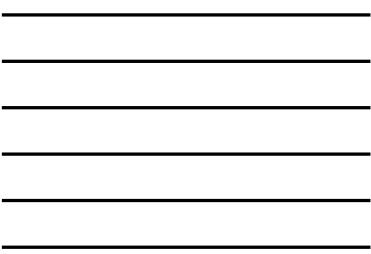

6

moat

ball: _____

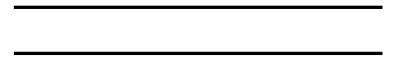

spot: _____

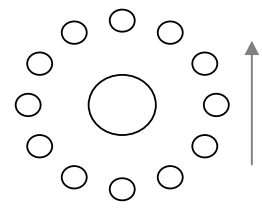

note: _____

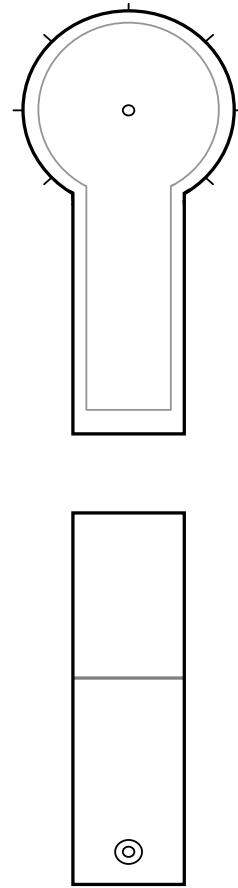
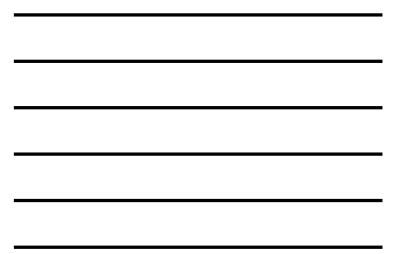

11

wall

ball: _____

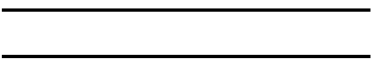

spot: _____

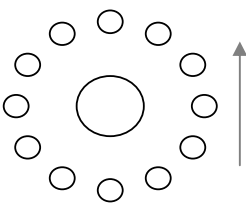

note: _____

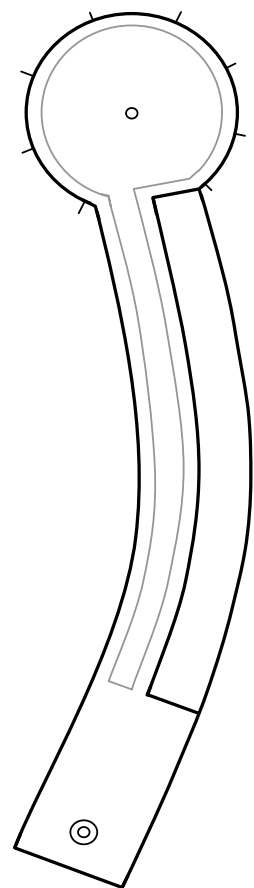

8

volcano

ball: _____

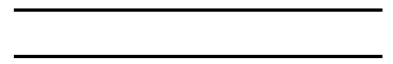

spot: _____

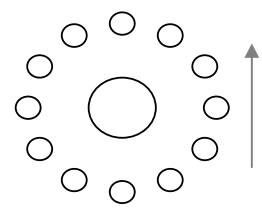

note: _____

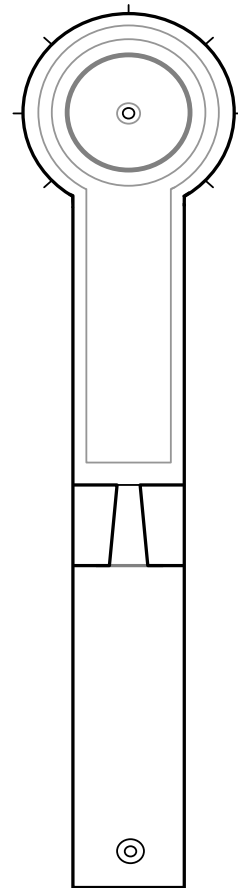

7

hammer cage

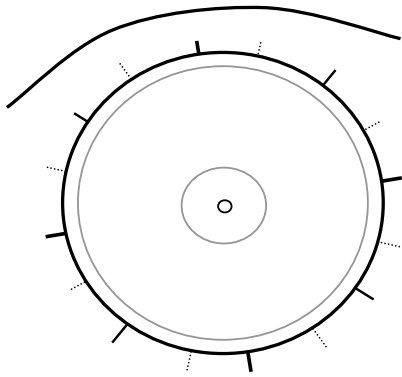

ball: _____

note: _____

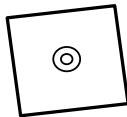

12

wide angle

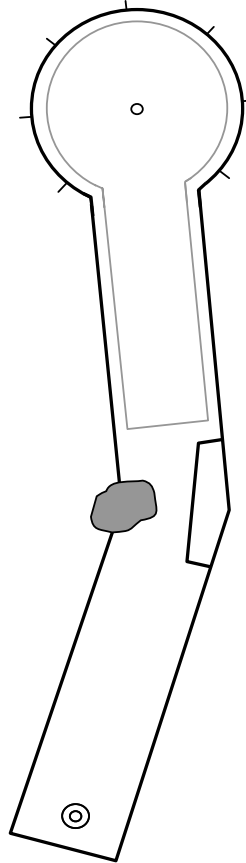

ball: _____

spot: _____

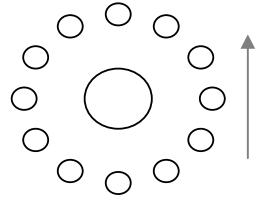

note: _____

ball: _____

9

open corner

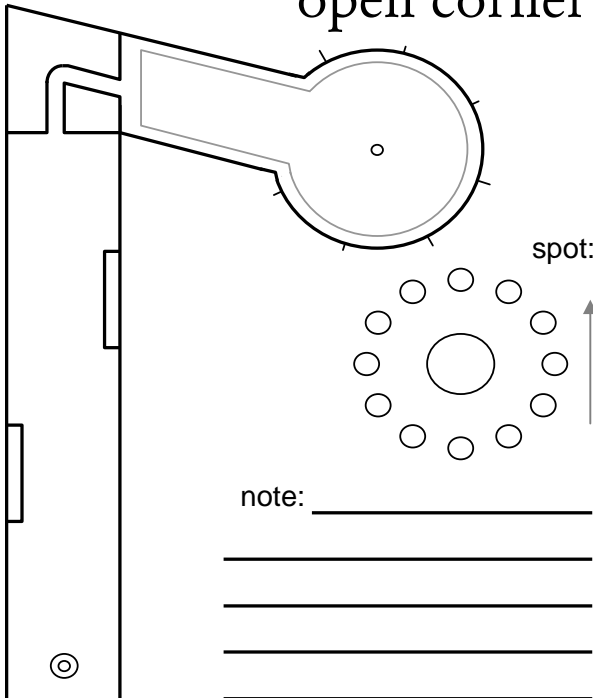

spot: _____

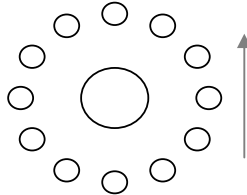

note: _____

10

triple hill

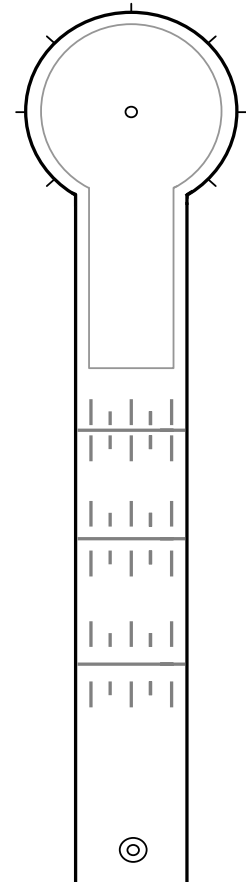

ball: _____

spot: _____

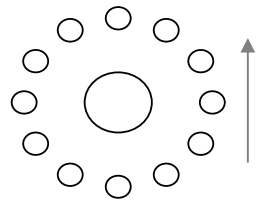

note: _____
